

eca3G Perfect Ground System

(US Patent No. 7,652,865 B2 – Grounding Device which not need to be buried in Ground)

Proven performances at various national security sites :
Over 4,000 sites for 17yrs, Protection Success rate : 99.88%
 Registered product at US Army Foreign Technology Database (GSTW)



the 3rd **Generation Digital** Grounding Apparatus
 for Perfect Lightning Surge Protection
 without burying in Ground



LM-Series



TNC-Series



LP-Series



TM-Series



PGS On-line
Monitoring system



| US PATENT 7,652,865 B2 |



| SIRIM TEST : IEC 61643-1 |



| CE No. N8 13 12 85780 001 |

- » Total Lightning Protection(Targeting 100% protection)
- » Provide Equi-potential, common grounding function (near zero N-G Potential difference assured- below 0.2 V)
- » Patented technology(USA, PCT, Korea)
- » Product Liability Insurance in Korea
- » Digital Grounding Apparatus
 - Need not additional grounding rod
 - Need not low earthing resistance
 - Grounding without burying in Ground

Especially for advanced networked electronic digital, IT systems

Since 1999, (GROUND Co.,) has provided total lightning protection solution pursuing 100% perfect protection, and has implemented remarkable successful performances with 99.88% protection rate for 17 years mostly for National Security Facilities. PL insurance has been provided to the clients together with highly credible technology and further satisfaction.

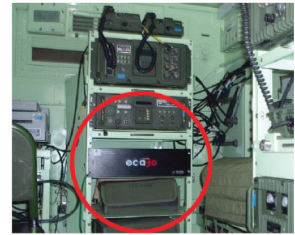

Environment for Lightning protection is changed as below, so should adopt different concept of Grounding system.

- Most of electronic, communication, data systems are connected under network
- IC chips / Semi-conductors become high integrated level with very thin internal circuit which is very weak from surge intrusion, and damaged short circuit status could not be seen from outside, Modern systems adopt Automation operation which adopt many IC chips, and will have more troubles from lightning surge intrusions.
- Global warming occurs more frequent lightning, multi-stage lightning (not simple single lightning) which normal surge protective device could not care.
- Near-by direct lightning affects your systems under GPR effect (Ground Potential Rise) which is shown very frequently at out-door or isolate buildings or isolate facilities.
- N-G potential difference affect to IC chips of low voltage operation with easier surge damage, data-signal error.



eca3G will provide ideal perfect lightning protection with integrated surge protection for your systems in the protection zone, common grounding, equi-potential function, surge elimination via energy conversion function, and does not require grounding rod and not require low grounding resistance, targeting perfect lightning surge protection for advanced networked systems.

eca3G will provide perfect protection solution for following environment.

- Networked, Automated, Data communication systems which require integrated lightning surge protection.
- Rocky, mountain area where could not get low grounding resistance for systems.
- Mobile Tactical vehicles which have difficulties to install grounding rod or could not get good earthing.
- Isolate/remote systems in the field are easily exposed from GPR (Ground Potential Rise)
- Frequently surge damaged sites which could not find perfect protection solution
- National security facilities should be operated 365/24 under bad weather, frequent-lightning environment.





Brief Technology Information

eca3g can detect surge, convert surge energy, neutralize, eliminate surge which may enter into the systems via power line, data line and conductive structures (such as water & gas piping lines, hydrant, steel structures), also from reverse surge (GPR etc).

eca3g has energy conversion and neutralization function to convert electric characteristics of surge into arc, heat, neutralization, and eliminate the surges.

eca3g makes EQUI-POTENTIAL environment of all the equipment and conductive parts in protecting zone, which improve earthing resistance also.

eca3g provide **INTEGRATED SURGE PROTECTION** to be able to connect max **20** ground points(LM model).



eca3g Component Units

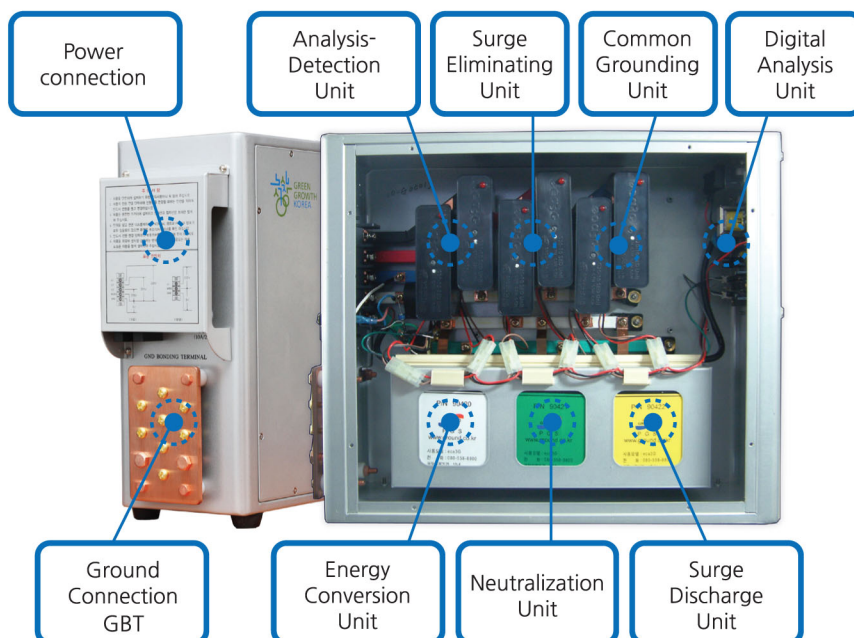



eca3G - Total Integrated Lightning Surge Protection

- Free from Grounding Rod, free from low Earthing Resistance
- Perfect protection for Military electronic, communication, radar system, vehicle/shelter systems.

○ Provide maximum field operation efficiency with total integrated lightning protection

- No need to install additional secondary grounding rods.
- No need to acquire low earthing resistance, but secure equi-potential common grounding.
- Provide neutral-ground potential difference within 0.2 volt which is important for advanced electronic systems.
- No need to install grounding rod for mobile military vehicle/shelter system for communication, rader, C4i tactical

○ Perfect total lightning protection for

- Military Communication, Rader, Broadcasting systems
- Rocky, mountain area where could not get low grounding resistance
- **Mobile Rader / Communication vehicles** without Grounding Rod
- Frequently surge damaged sites which could not find perfect protection solution yet.
- Airport Instrument landing guide system
- Border surveillance, coastal rader system
- IP CCTV network system



〈Navy Communication system〉

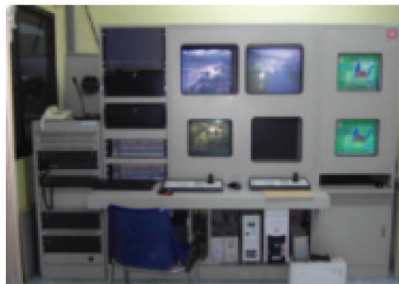

〈Thailand Army Ammunition〉

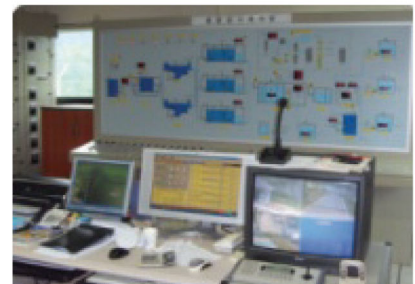

〈Water Plant control〉



Low-Altitude Surveillance Radar
http://www.lignex1.com:8001/en_US/product/product_detail.jsp?pid=19&scode1=&scode2=&scode3=&skey



〈 Mobile communication vehicle 〉



〈 Mobile communication vehicle 〉

○ Countries using eca3G Product

- Korea for 17 years**, mostly for National Security about 4000 sites – Navy, border surveillance, digital TV, Mobile radar vehicle
- Malaysia for 5 years** for Police, Telecom Malaysia, Army PABX, Air force radar, Airport localizer system
- Thailand for 3 years** for Satellite station, Army ammunition depot, Border surveillance, Army video network
- India for 2 year** for Glide path of airport, Military engineering, Police communication, Satellite Research Institute, Telecommunication

LM-Series



Model	Specification	Dimension (WxHxD/mm)	Weight (Kg)
LM-1P	1 Φ 2w/220V/160KA	150 x 360 x 450	13.5
	1 Φ 3w/220V/320KA		
LM-3P	3 Φ 4w/220V/480KA		14.5
	3 Φ 4w/380V/480KA		

Application

Power distribution system (Distribution Board),
 Communication system, Computing system,
 Broadcasting system, Automation, control system,
 Signaling system, Firefighting system, PLC

TM-Series



Model	Specification	Dimension (WxHxD/mm)	Weight (Kg)
TM-1P	1 Φ 2w/220V/80KA	482 x 132 x 460	13.5
	1 Φ 3w/220V/160KA		
TM-3P	3 Φ 4w/220V/240KA		14.5
	3 Φ 4w/380V/240KA		

Application

Model for 19 inch standard Rack installation

LP-Series

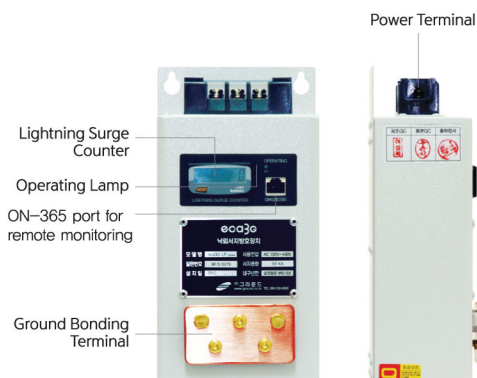

Model	Specification	Dimension (WxHxD/mm)	Weight (Kg)
LP-1P	1 Φ 2w/220V/80KA	120 x 233 x 87	1.8
	1 Φ 3w/220V/120KA		
LP-3P	3 Φ 4w/220V/240KA		
	3 Φ 4w/380V/240KA		

Application

Communication system, CCTV, DVR,
 PLC, Computing system

eca3G Product Information

TNC



Model	Specification	Wt(kg)	Size(W×H×D/mm)
TNC	1 Φ 2w/220V/240KA/0.3kVA	9	146 × 196 × 290
	1 Φ 2w/220V/240KA/1kVA	25	230 × 345 × 408
	1 Φ 2w/220V/240KA/2kVA	32	250 × 345 × 408
	1 Φ 2w/220V/240KA/3kVA	39	270 × 345 × 408
	1 Φ 3w/220V/240KA/5kVA	52	320 × 345 × 408
TNC-P-1P	1 Φ 2w/250V/480KA/100KVA	10.5	180 × 290 × 315
TNC-P-3P	3 Φ 4w/500V/960KA/300KVA	11.5	180 × 290 × 315

TNC - P



Application

- Total lightning protection for
- Single phase of Delta power supply,
 - Power supply without ground or not clear ground,
 - Power supply with TT ground,
 - Power line without neutral line
 - power line which cannot be ground

ON-365 SYSTEM

ON-365 system is the real-time monitoring system for eca3G functions at client' site
 With this service, we can provide further Performance Guarantee Maintenance Service

ON-365 SYSTEM : Operational Concept

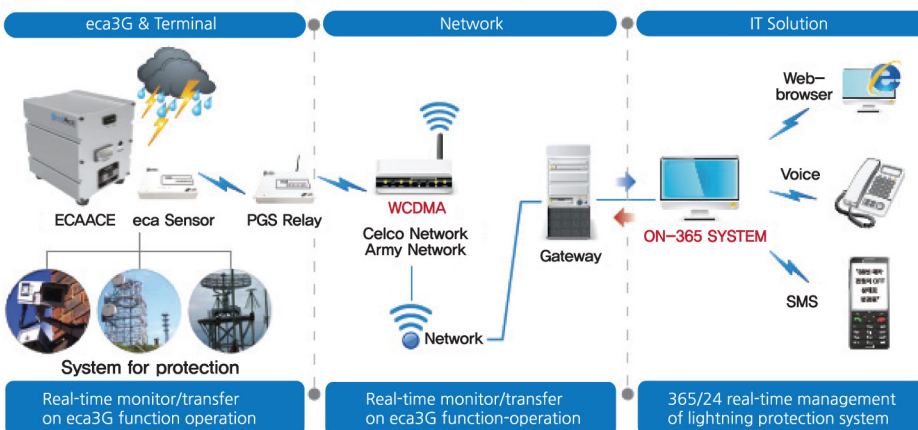

Model	Description
ON-36-PC-PR1	Monitoring Program
ON-36-RL-WE1	Internet Terminal
ON-36-RL-RS1	Intranet Terminal
M2M Modem	WCDMA Terminal

eca3G is not SPD or TVSS or Surge Arrestor, but total surge protection device with Ground, equi-potential element

Item	Description				Remark
MODEL	eca3G – LM	eca3G – TM	eca3G – LP	eca3G–TNC/P	Other small models available for Special purpose (traffic light control, CCTV etc)
Major Application	Main incoming DB	Vehicle, Shelter 19" Rack Type	Sub / small DB	Delta power, TT ground	
Major functions	Total protection for electronic, communication, IT systems from lightning, induced surge, Ground Potential Rise Common ground, equi-potential function, N-G : below 0.2V				USA Patent, PCT, Korea Patent
Product assurance	5 years warranty, Product Liability Insurance (in Korean territory), (optional : 10 years warranty program with ON 365 / PGS service)				G-50 model
ON-365 Service	On-line, real-time monitoring on the performance, operation status, health, surge intrusion counting of eca3G™ by M2M base (machine-to-machine)				10 years warranty program with Modular, Block designed model
Power consumption	Below 5w				adopt surge current for operation
Uc	275V (maximum continuous operating voltage)				
Maximum Discharge Current/Imax	160kA~480kA/	160kA~240kA/	80kA~240kA/	160kA~480kA/ (960 KA/P-3P)	IEC 61643-1 Class II SIRIM/ KERI Test Report
Voltage Protection Level / Up	2.5KV	1.0~2.5KV	1.5KV	0.9KV	
Weight(kg)	13 ~ 15	13 ~ 15	1.8	9 ~ 52	
Size(W×H×D/mm)	150×360×450	485×135×450	130×205×96	270×345×408 (3kV)	Can be changed upon design improvement
Operation Temp	- 40°C ~ +80°C				
Installed Location	Power Distribution Board, UPS, AVR				Parallel connection to power line (except TNC model)
Others	Multi-stage lightning protection(patent), built-in surge counter, Main Ground Bar for common grounding Enable for centralized total real-time maintenance support by ON-365 via M2M				

eca3G Installation configuration

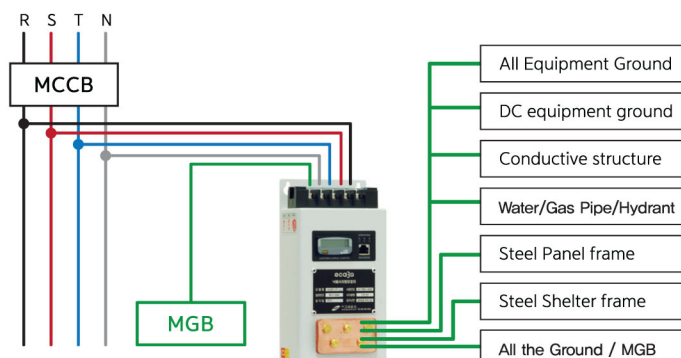

eca3G has been extensively installed in South Korea for Navy, Army, Air Force, Special Government Departments, National Institutions, Water Service Management Agencies, Railways, Subways, Road Construction Sites, Sewage Treatment Plants, Drinking Water Treatment Plants, Broadcasting Stations, Telecom Base Stations, Universities, Hospitals, Research Institutes, Factories, Golf Clubs, Gas Corporations, Hydro-Nuclear Power Corporations, Mobile Communication Service Providers, Mobile Shelters and etc.

Certificates



USA Patent



CE MARK

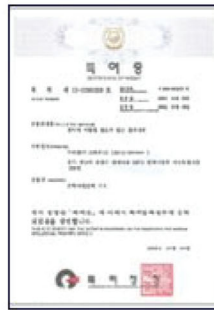

Certificate of Korean patent



Certificate for Good product approved by public Procurement Service



Certificate of INNO-BIZ



ISO 14001



ISO 9001

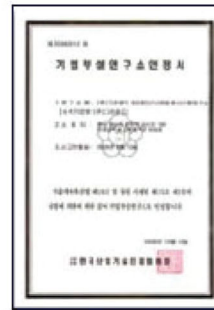

Certificate of enterprise research laboratory

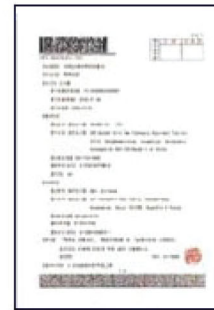

International Patent



Certificate of Product Liability Insurance

TOTAL LIGHTNING PROTECTION SYSTEM



US Patent



INNOBIZ Enterprise



Korea Patent



Q mark Quality Assurance



CE MARK



ISO9001:2008 ISO4001:2004



Superior Defense SME Goods



R&D Venture Enterprise



PL insurance 1bil Won



SIRIM QAS

GROUND Co., Ltd.

HQ, Factory, R&D Institute : 950, Deokum-ro, Kumwang-up, Eumsung-gun, Chungbuk , 27681 , Korea
 Tel : +82-10-3651-3926 (KOR) / +60-12-642-1956 (MAS)
 +82-2-572-0008 (KOR) / Fax : +82-2-572-8888
 Homepage : www.ground.co.kr (Kor) / www.eca3g.com (Eng)
 E-mail : johanbinkim@gmail.com , ceo@ground.co.kr